

VG2053/VG4053



VCR User's Guide



We bring good things to life.

Important Information

WARNING

To reduce the risk of fire or shock hazard, do not expose this VCR to rain or moisture.

WARNING

RISK OF ELECTRIC SHOCK
DO NOT OPEN

TO REDUCE THE RISK OF ELECTRIC SHOCK, DO NOT REMOVE COVER (OR BACK). NO USER SERVICEABLE PARTS INSIDE. REFER SERVICING TO QUALIFIED SERVICE PERSONNEL.



This symbol indicates "dangerous voltage" inside the product that presents a risk of electric shock or personal injury.



This symbol indicates important instructions accompanying the product.

Cautions

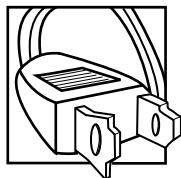

Caution: To prevent electric shock, match wide blade of plug to wide slot, fully insert.

Attention: Pour éviter les chocs électriques, introduire la lame la plus large de la fiche dans la borne correspondante de la prise et pousser jusqu'au fond.

Do not defeat the safety feature of the plug. The wide blade fits into the wall socket only one way. If you need an extension cord, make sure it matches the plug of the VCR.

For U.S.A. — Operate VCR only on 120 volts, 60Hz AC power (normal house power).

FCC Regulations state that unauthorized changes or modifications to this equipment may void the user's authority to operate it.

Note To Cable TV Installer

This reminder is provided to call your attention to Article 820-40 of the National Electrical Code (Section 54 of the Canadian Electrical Code, Part 1) which provides guidelines for proper grounding and, in particular, specifies that the cable ground shall be connected to the grounding system of the building as close to the point of cable entry as practical.

Product Registration

Please fill out the product registration card and return it immediately. Returning this card allows us to contact you if needed.

Keep your sales receipt to obtain warranty parts and service and for proof of purchase. Attach it here and record the serial and model numbers in case you need them. The numbers are located on the back of the VCR.

Model No. VG2053/VG4053

Serial No. _____

Purchase Date: _____

Dealer/Address/Phone: _____

Table of Contents

Important Information

Warnings	i
Cautions	i
Note to Cable TV Installer	i
Product Registration	i

Hooking Up the VCR

Choosing a Hookup	2
Antenna or Cable System Without a Cable Box	3
Cable System With Cable Box to Unscramble All Channels	4
Cable System With Cable Box to Unscramble Only Pay Channels	5
Connecting Two VCRs for Copying Tapes	6

Setting Up the VCR

Startup	
Check Accessories With VCR	7
Insert Batteries in Remote	7
Turn on TV	7
Turn on VCR	7
Place Channels in the VCR's Memory	8
Add or Remove Channels from the VCR's Memory	8
Use TV•VCR Button	9
Set the Time and Date	9

Using the Remote Control

VCR Function Buttons	10-11
----------------------	-------

Playing a Tape

Operating Instructions	12
To Play a Tape	12
Using the Playback Features	
Display Clock or Time Counter	13
Time Counter	13
Clear Counter	13
Zero Search	13
Picture Search	14
Slow Motion	14
Index Search	14
Commercial Scan (SKIP Button)	15

Pause for Stop Action	15
Frame Advance	15
Automatic Tracking	15
Manual Tracking	15

Recording a Program

Types of Recordings	16
Recording Speeds	16
Recording Pause	16
Basic Recording – Operating Instructions	16
To make a recording	16
To stop a recording	16
Watch a TV Channel While VCR is Recording a Different Channel	16
One Touch Recording	17
Operating Instructions	17
Stopping a One Touch Recording in Progress	17
Recording While You're Away	
Setting a Timer Recording	18
Stopping a Timer Recording	18
Timer Recording From the VCR's Line Input	19
Checking or Clearing Timer Recordings	19
Using Two VCRs for Copying and Editing Tapes	20

References

Specifications	21
Cleaning the VCR	21
Location of Controls	
Front Panel	22
Back Panel	23
Display Panel	24
Limited Warranty	25
Trouble Checks	26-27
Index	28

Choosing a Hookup

The hookups on pages 3 through 5 are divided into two hookup types: Basic (A) and Advanced (B).

The basic hookup shows the backs of TVs that have only an antenna/cable connection. It is the easier of the two and additional accessories may not be needed.

The advanced hookup shows the VCR hooked up to a monitor/receiver (TV with audio and video jacks) using a signal splitter. This connection may improve the picture quality as well as convenience of operation.

Answer the questions to choose the hookup for your VCR.

1. How do you receive your TV signals?

Choose one answer from below.

- A. Outside antenna – Turn to page 3.
- B. Rabbit ears (set-top) and/or bow tie antenna – Turn to page 3.
- C. Cable System – Go to question 2.

2. What type of Cable-TV system* do you have?

Choose one answer from below.

- A. Cable without a box – Turn to page 3.
- B. Cable box to unscramble all the channels – Turn to page 4.
- C. Cable box to unscramble only pay channels, such as HBO, Showtime, Cinemax, etc. – Turn to page 5.

*You may need to contact your local cable company for assistance.

Optional Hookups

How to hook up two VCRs for copying tapes?

- A. Select a hookup by answering questions 1 and 2 above.
- B. Then, modify the connections as shown on page 6.

Antenna or Cable System Without a Cable Box

A. Basic hookup.

Use this hookup for a simple connection which requires fewer accessories.

1. Set the CH3 CH4 switch on back of VCR to either channel 3 or 4.

Tune the TV to this channel and use the TV•VCR button to watch the VCR.

2. Connect as shown.

This connection may require additional accessories not provided.

3. Plug in power cords of VCR and TV.

4. **Continue to page 8.**

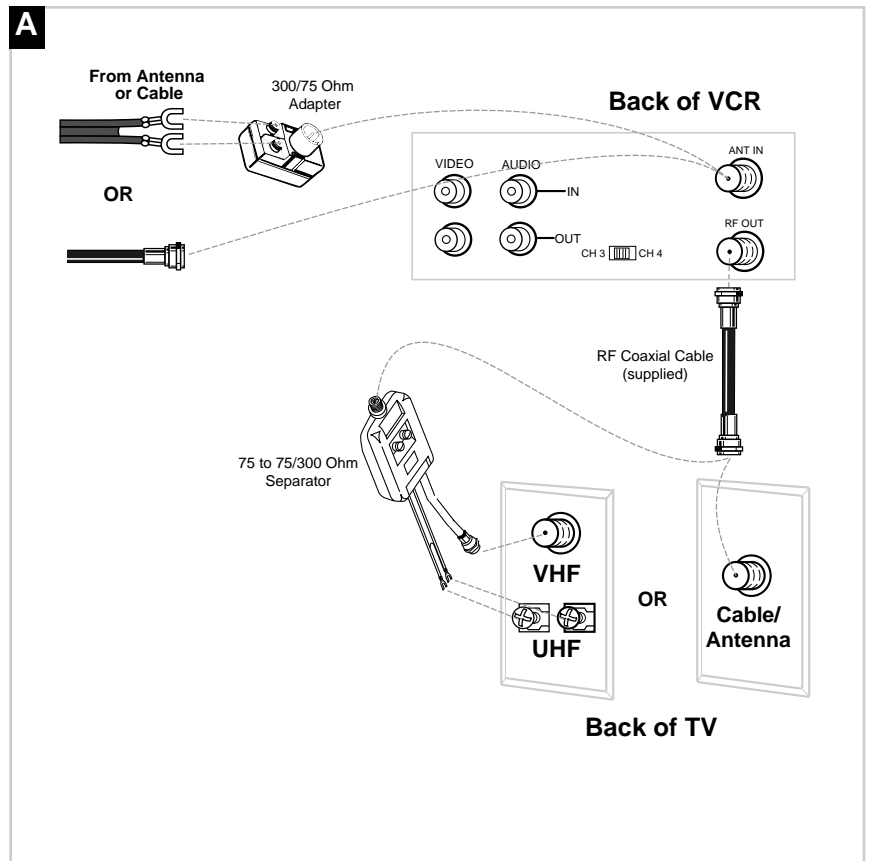

B. Advanced hookup.

Use this hookup for slightly improved picture quality and more convenient operation — use of the TV•VCR button is not required.

1. Connect as shown.

This connection requires additional accessories not provided.

If your TV is not stereo, you may need a Y-adapter to hear sound from both channels.

2. Plug in power cords of VCR and TV.

3. **Continue to page 8.**

Tune the TV to its video input to watch the VCR.

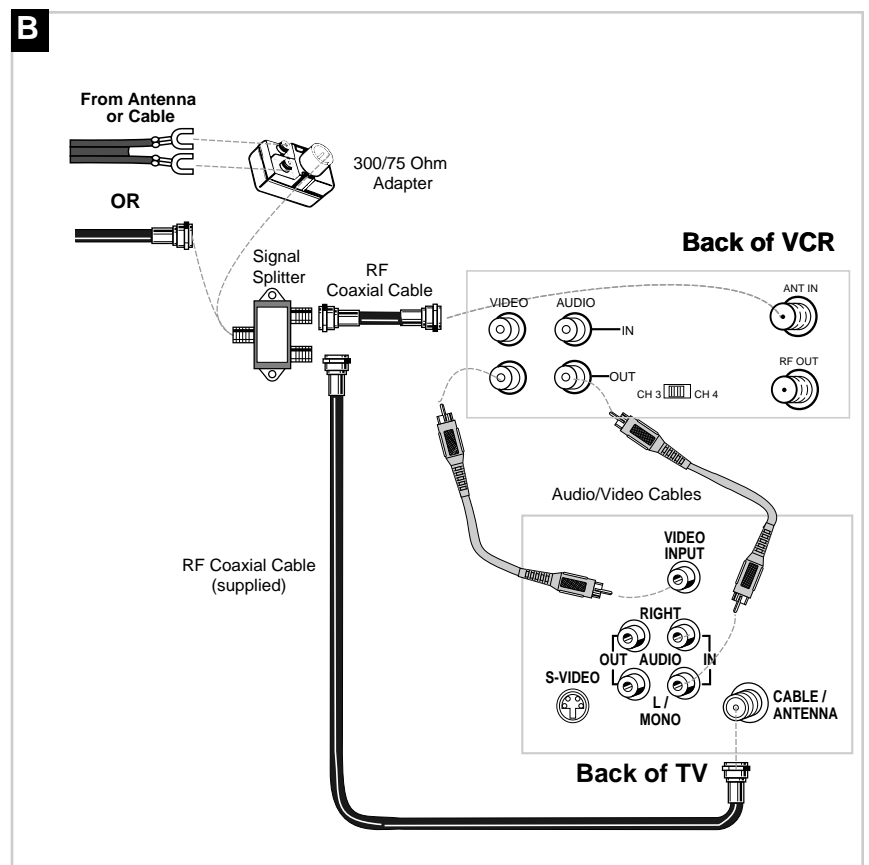

Cable System With Cable Box to Unscramble All Channels

A. Basic hookup.

Use this hookup for a simple connection which requires fewer accessories.

1. **Set the CH3 CH4 switch on back of VCR to either channel 3 or 4.**

Tune the TV to this channel and use the TV•VCR button to watch the VCR.

2. **Connect as shown.**

This connection may require additional accessories not provided.

3. **Plug in power cords of VCR, TV, and cable box.**

4. **Continue to page 8.**

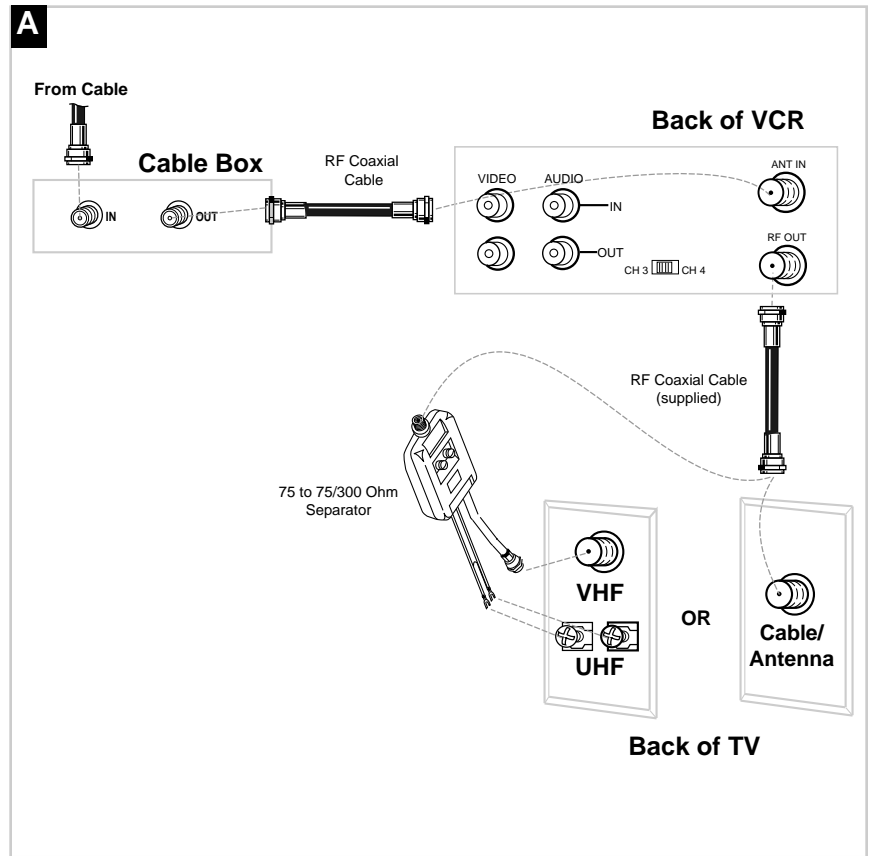

B. Advanced hookup.

Use this hookup for slightly improved picture quality and more convenient operation — use of the TV•VCR button is not required.

1. **Connect as shown.**

This connection requires additional accessories not provided.

If your TV is not stereo, you may need a Y-adapter to hear sound from both channels.

2. **Plug in power cords of VCR, TV, and cable box.**

3. **Continue to page 8.**

Tune the TV to its video input to watch the VCR.

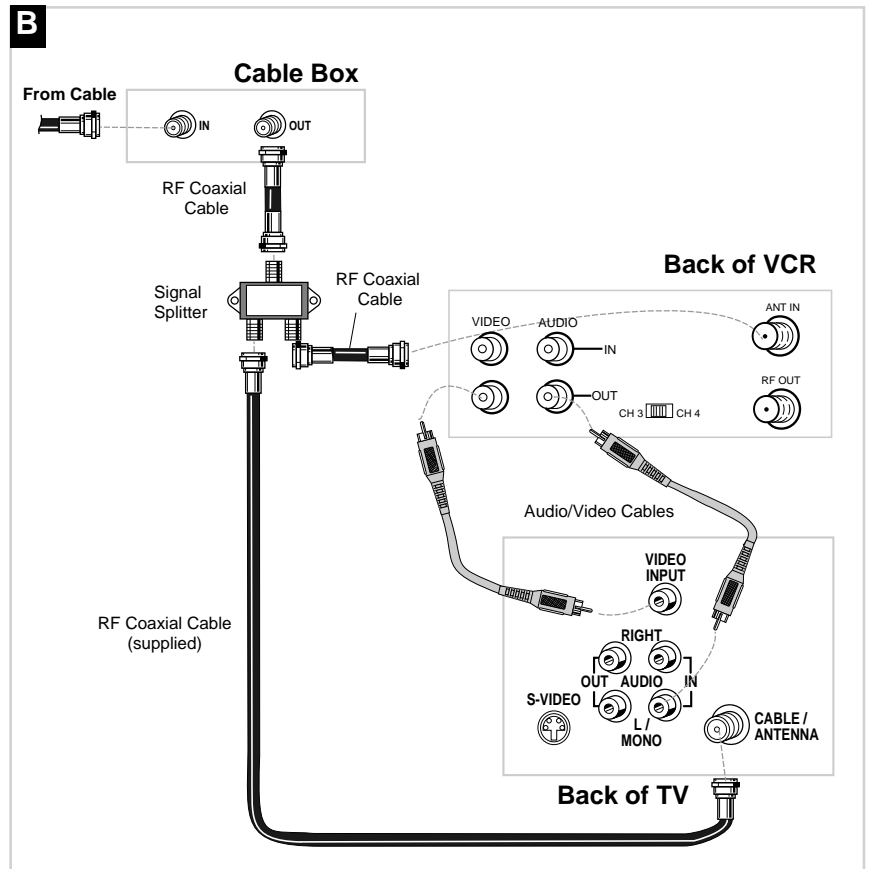

Cable System With Cable Box to Unscramble Only Pay Channels

(such as HBO, Showtime, Pay-Per-View, etc.)

A. Basic hookup.

Use this hookup for a simple connection which requires fewer accessories.

1. Set the CH3 CH4 switch on back of VCR to either channel 3 or 4.

Tune the TV to this channel and use the TV•VCR button to watch the VCR.

2. Connect as shown.

This connection may require additional accessories not provided.

3. Plug in power cords of VCR, TV, and cable box.

4. **Continue to page 8.**

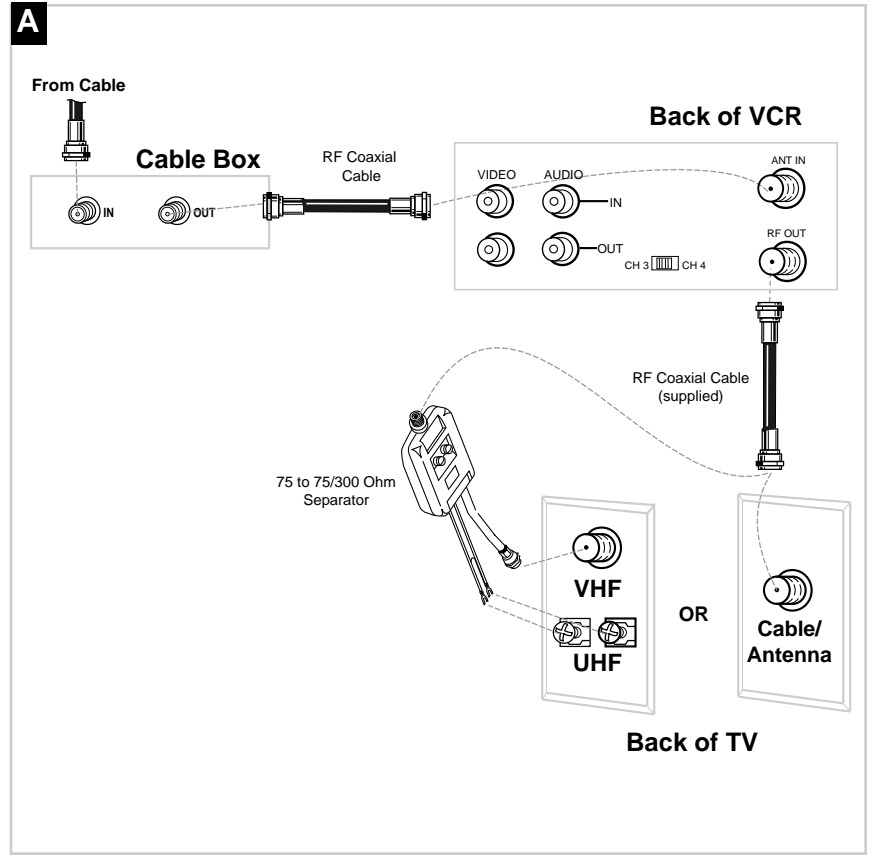

B. Advanced hookup.

Use this hookup for slightly improved picture quality and more convenient operation — use of the TV•VCR button is not required.

1. Connect as shown.

This connection requires additional accessories not provided.

If your TV is not stereo, you may need a Y-adaptor to hear sound from both channels.

2. Plug in power cords of VCR, TV, and cable box.

3. **Continue to page 8.**

Tune the TV to its video input to watch the VCR. View all pay channels through the VCR.

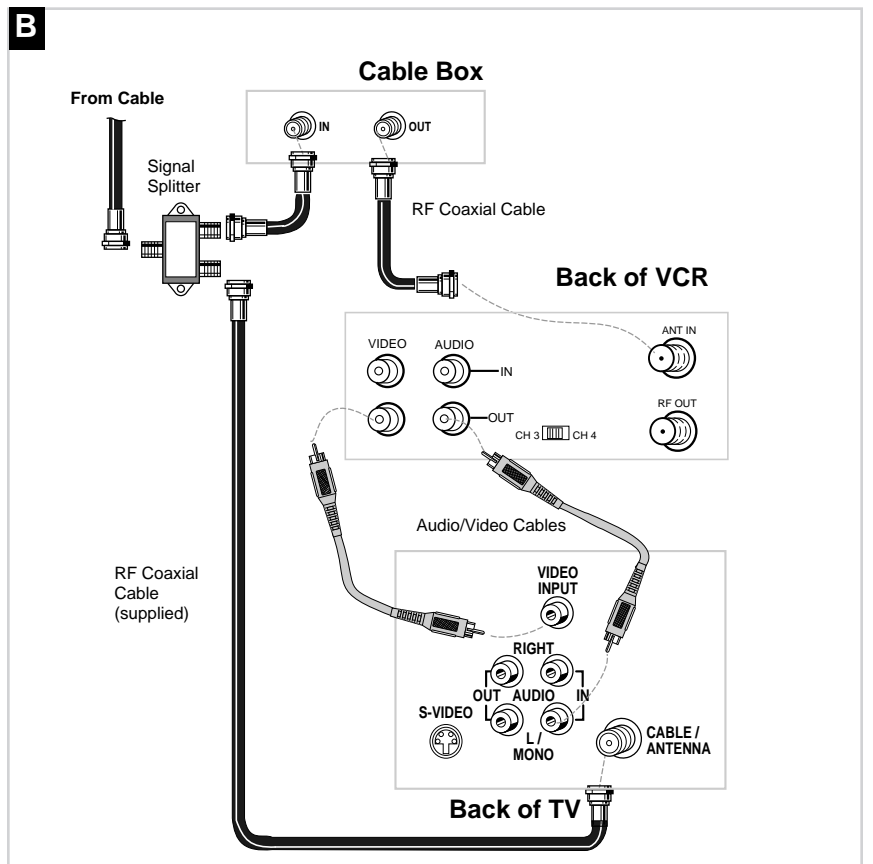

Connecting Two VCRs for Copying Tapes

Option A hookup.

Use this hookup for a simple connection which requires fewer accessories.

1. **Select a hookup from pages 2 through 5 and then modify with this connection.**
2. **Set the CH3 CH4 switch on the playback VCR to either channel 3 or 4.**
Tune the recording VCR to this channel to receive the signal from the playback VCR.
3. **Connect as shown.**
This connection may require additional accessories not provided.
4. **Plug in power cords of VCRs and TV.**
5. **Continue to page 8.**

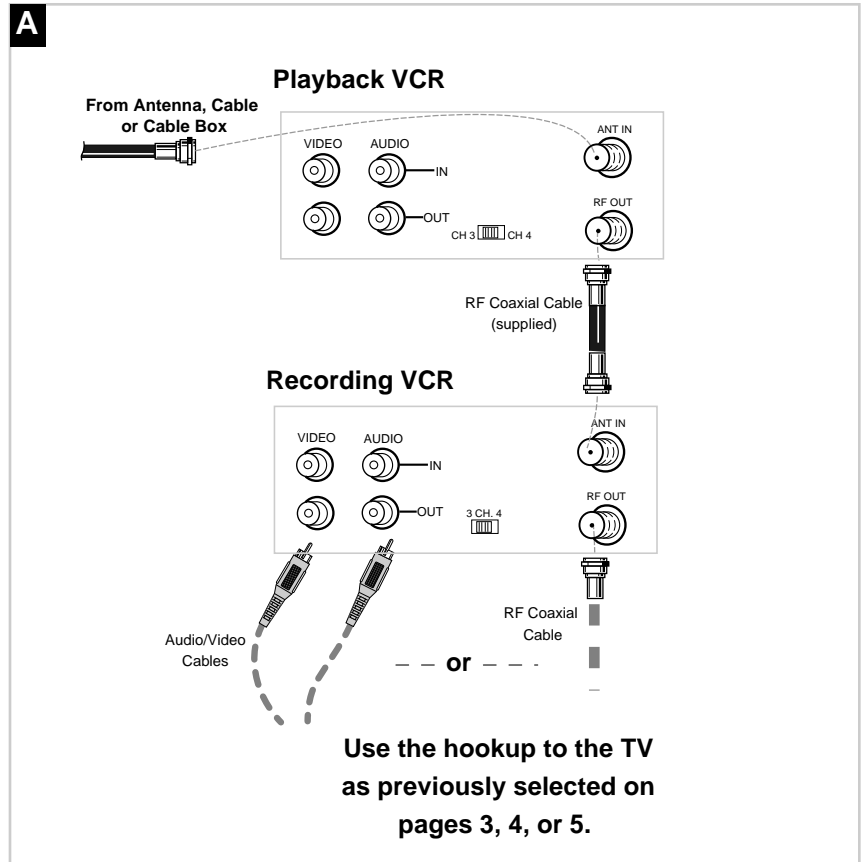

Option B hookup.

Use this hookup for slightly improved copy quality and more convenient operation — use of the TV•VCR button is not required.

1. **Select a hookup from pages 2 through 5 and then modify with this connection.**
2. **Connect as shown.**
This connection requires additional accessories not provided.
If your other VCR is not stereo, you may need a Y-adaptor to hear sound from both channels.
3. **Plug in power cords of VCRs and TV.**
4. **Continue to page 8.**

Select the line (audio/video) input (L) on the recording VCR to receive the signal from the playback VCR.

Caution: The unauthorized recording of television programs and other materials may infringe the rights of others.

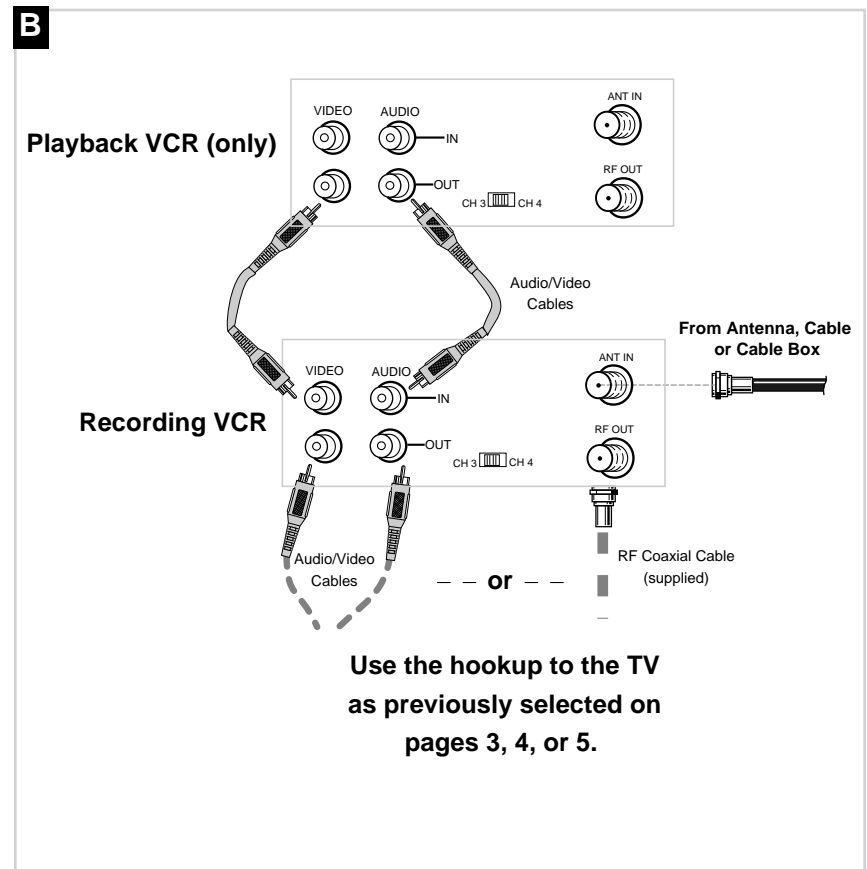

Startup

1. Check accessories with VCR.

Contact your dealer if any items are missing.

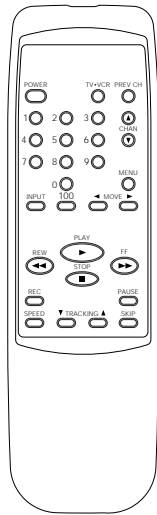

VG2053 Remote
(Stock No. 229652)

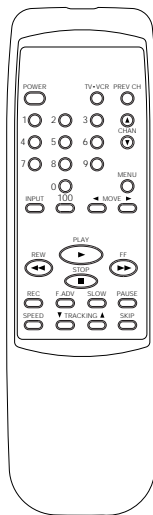

VG4053 Remote
(Stock No. 221391)

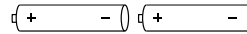

2 "AA" Batteries

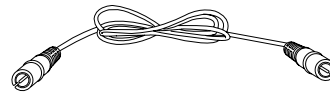

RF Coaxial Cable
(Stock No. 221392)

2. Insert batteries in remote.

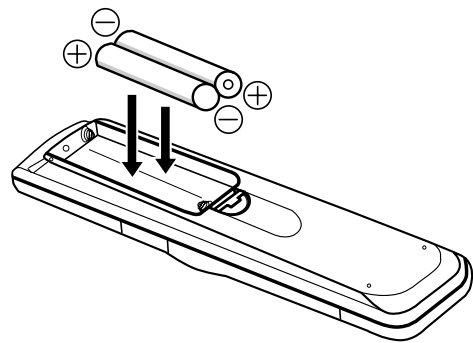
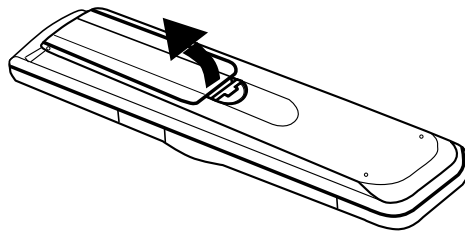

3. Turn on the TV.

- A. Turn on the TV.
- B. If you used one of the basic hookups, tune the TV to the channel selected with the CH3 CH4 switch on back of VCR.
If you used one of the advanced hookups, tune the TV to the TV's video input.
(See TV owner's manual for details.)

4. Turn on the VCR.

- A. Press **POWER** on the remote. The power and VCR indicators light in the VCR's display panel.
- B. Press **CHAN** up or down to change channels.

5. Place channels in the VCR's memory.

The first time you turn on the VCR or after a power interruption, perform the AUTO CHANNEL SEARCH so that your VCR can memorize the channels available through your signal source—cable or antenna.

Also, if you change the signal source, you will need to perform AUTO CHANNEL SEARCH again.

- A. Press MENU to display the VCR MAIN MENU on the TV screen. If this menu does not appear:
 - Make sure TV is tuned to same channel as CH3 CH4 switch on the VCR or the TV's video input (refer to TV's manual).
 - If you use a basic hookup, check the VCR indicator in display panel — it should be on. Press TV•VCR to turn it on.
 - Check the connections.
- B. Press 3 to display the CHANNELS menu.
- C. Press 1 to select the signal source, SIGNAL:CABLE or ANTENNA.
- D. Then, press 2 to begin AUTO CHANNEL SEARCH. If you are using a cable connection as your signal source, 125 channels are searched for the strongest signals and the letter C appears on the VCR's display panel. If you are using an antenna connection, 69 channels are searched.

Wait until the channel numbers stop changing. This takes about one to two minutes. The TV tunes to the lowest channel found. Then, pressing CHANNEL up or down selects only the active channels.

If you need to change the signal source setting, select 1 in the CHANNELS menu.

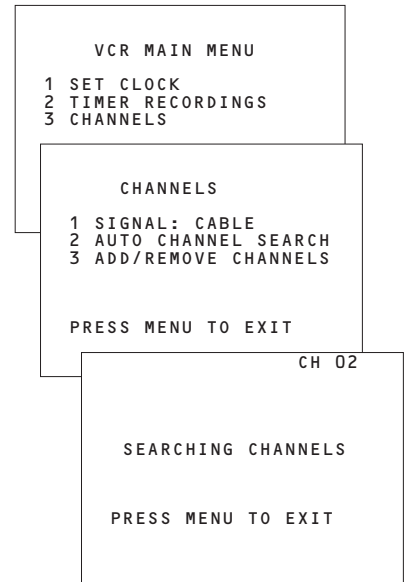

6. Add or remove channels from the VCR's memory.

You may want to add or remove channels if some of the channels are not active, have weak signals, or you do not want to watch them.

You must place channels in memory using the AUTO CHANNEL SEARCH feature *described above* before you can add or remove channels.

- A. Press MENU on the remote to see the VCR MAIN MENU.
- B. Press 3 to display the CHANNELS menu.
- C. Press 3 to display the ADD/REMOVE CHANNEL menu.
- D. Select the channel you want to add or remove by pressing the number buttons or using the CHAN up or down buttons on the remote.
- E. Press the MOVE left button to remove the selected channel. Press MOVE right button to add the selected channel.
- F. When you are finished adding or removing channels, press MENU to remove the menu and resume normal viewing.

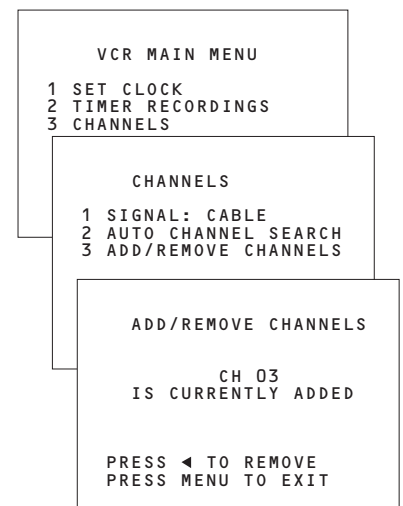

Startup

7. Use TV•VCR button.

Skip this step if you used one of the advanced hookups.

When using one of the basic hookups, the TV•VCR button lets you switch between the picture coming from the VCR or television channels. Also, this button lets you record a program on the VCR while watching another channel on the TV.

- A. Press TV•VCR to see the picture from the VCR.
The VCR indicator lights in the display panel.
- B. Press CHAN up or down to change channels on the VCR.
- C. Press TV•VCR to see the TV channels.
The VCR indicator does not light in the display panel.
Change channels using the TV's remote.
- D. Return the TV to the VCR viewing channel — CH3 or CH4.
- E. Press TV•VCR to switch back to the picture from the VCR.

8. Set the time and date.

When you first turn on the VCR, --:-- appears in the clock area of the VCR's display panel.

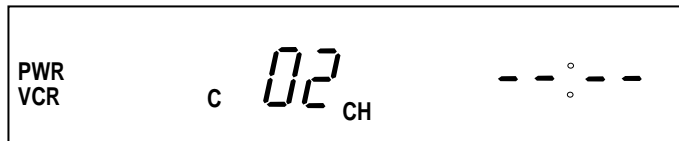

- A. Press MENU on remote to display the VCR MAIN MENU on the TV screen.
- B. Press 1 to display SET CLOCK.
- C. Enter the time and date with the number buttons on the remote.
 - Press 0 before single-digit numbers.
Example: press 0, then 5, then 0, then 7 for a time of 5:07.
 - Press 1 for AM or 2 for PM.
 - Press MOVE left or right on the remote to change incorrect entries.
- D. Press MENU to remove SET CLOCK from the TV screen and start the clock. The time appears in the VCR's display panel.

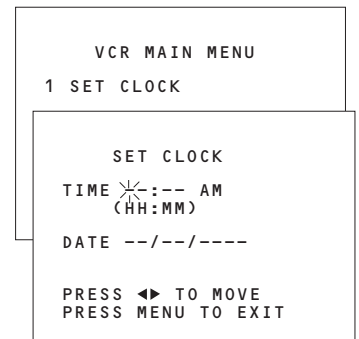

VCR Function Buttons

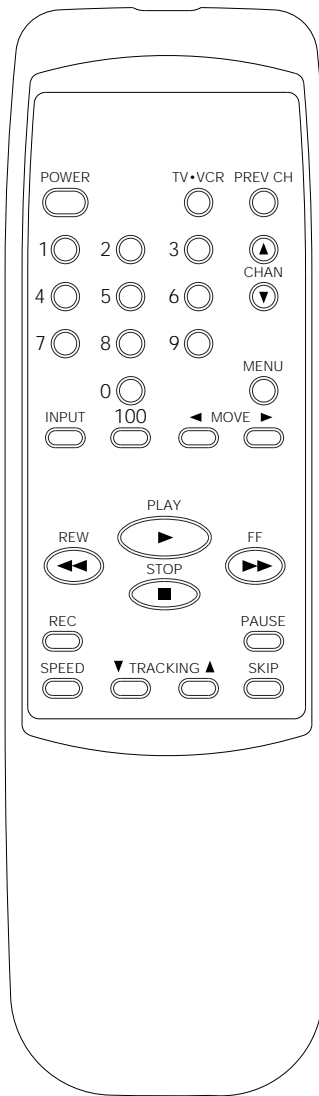

VG2053 Remote

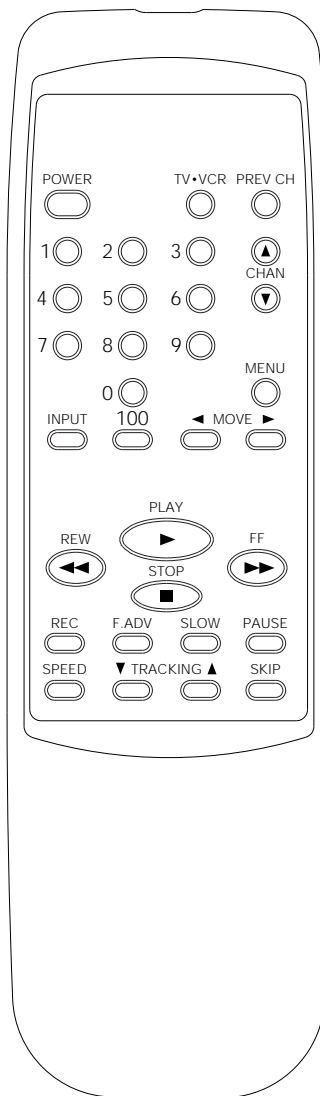

VG4053 Remote

100

Lets you select a channel number over 100.

CHAN (Channel up or down)

Selects the next higher or lower channel in the VCR's channel memory.

FF (Fast Forward)

Fast forwards the tape when the VCR is stopped.

Searches the picture in forward motion during playback—5 times normal speed in SP mode, 9 times normal speed in LP mode and 15 times normal speed in EP mode.

F. ADV (Frame Advance)

Lets you view one frame with each press of the button when the tape is in stop-action pause. **This feature is not available on the model VG2053.**

INPUT

Selects an input line.

Turns the line input on or off.

Line input refers to the signal coming from the component connected to the audio/video jacks on the back of the VCR.

MENU

Displays the VCR MAIN MENU on the TV screen.

Removes a menu from the screen.

MOVE left or right

Moves the cursor to correct an entry.

Numbers (0 through 9)

Selects a channel up to 99—press two numbers.

Selects a cable channel over 99—press the 100 button and two numbers. **Or** press and hold 1 until 1-- appears on the screen. Then, press the other two numbers.

VCR Function Buttons

(Continued)

PAUSE

Pauses action for viewing during playback. Press **PAUSE** again to resume normal playback.

Pauses recording to prevent recording of unwanted scenes.

Also, lets you pause a recording, then resume the recording.

PLAY

Plays a tape.

POWER

Turns the VCR on and off.

PREV CH (Previous Channel)

Switches between two channels.

Select one channel, then select another. Press **PREV CH** to switch between the two channels.

REC (Record)

Starts the VCR recording.

REW (Rewind)

Rewinds the tape when the VCR is stopped. Rewinds in high speed when you press **REW** when a tape is rewinding.

Searches the picture in reverse motion during playback—5 times normal speed in SP mode, 9 times normal speed in LP mode and 15 times normal speed in EP mode.

SKIP

Advances the tape 60 seconds during playback.

SLOW

Plays a tape in slow-motion. *This feature is not available on the model VG2053.*

SPEED (Tape Speed)

Selects a recording speed (SP, LP, EP).

STOP

Stops the VCR's normal functions such as record, playback, rewind, fast forward, and pause.

TRACKING up or down

Reduces the streaks that may appear on the picture.

Reduces picture "jitter" during pause. *In the model VG4053, reduces the streaks during slow motion playback.*

TV•VCR

Switches the picture signal so that it either comes from the VCR or the TV channel.

Operating Instructions

To Play a Tape

1. Turn on the TV and tune it to channel 3, 4, or the TV's video input to see the picture from the VCR.
2. Insert a tape in the VCR.
The VCR turns on automatically. The power and VCR indicators light. The tape automatically begins playback if the safety tab on the cassette has been removed.

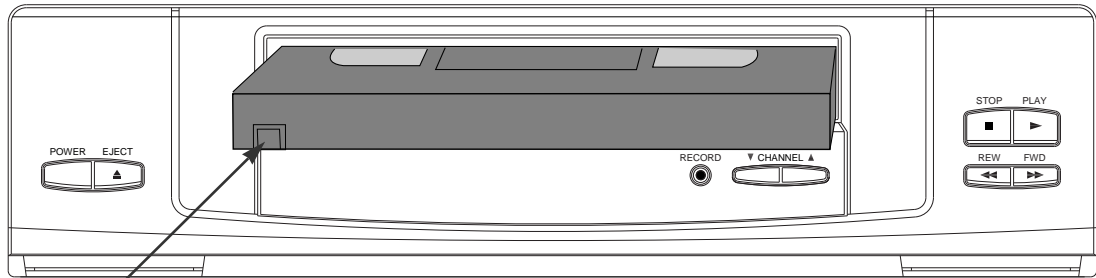

Safety Tab

3. Press PLAY, if necessary.
4. Press TRACKING up or down on the remote or VCR to remove any streaks from the picture if necessary.
5. Press STOP on the VCR or the remote.
6. Press REW on the VCR or the remote.
The VCR automatically rewinds the tape if it reaches the end of the tape during playback.
7. Press EJECT on the VCR to eject the tape once it is completely rewound.

Using the Playback Features

Display Clock or Time Counter

You can display the time counter or the clock in the VCR's display panel.

1. Press MENU to display the VCR MAIN MENU.
2. Press 4 to display the SEARCH/COUNTER menu.
3. Press 5 choose CLOCK or COUNTER.

Time Counter

The time counter shows the actual time it takes to record a program or play back a segment of a prerecorded tape. It helps locate the beginning or end of programs you taped. The time counter resets to 0:00:00 when the tape is ejected from the VCR.

For example, if you recorded a 30-minute program at the beginning of the tape, you would:

1. Insert the prerecorded tape.
2. Press MENU to display the VCR MAIN MENU.
3. Press 4 to display the SEARCH/COUNTER menu.
4. Press 5 to display only the counter in the VCR's display panel.
5. Press FF to fast forward the tape until 0:30:00 appears in the time counter.
6. Press STOP.

This is the end of the program. You can begin recording a new program.

Clear Counter

You can reset the time counter to 00:00 anywhere on a tape so that you can easily locate a tape segment.

1. Insert the prerecorded tape.
2. Display the time counter in the VCR's front panel, see above.
3. Fast forward or rewind to the location where you want to reset the timer to 00:00.
4. Press MENU to display the VCR MAIN MENU.
5. Press 4 to display the SEARCH/COUNTER menu.
6. Press 3 to reset the counter to 00:00.

Zero Search

The zero search feature lets you quickly return to a counter reading of 0:00:00 anywhere on the tape. This is especially convenient when you want to watch a segment of a tape several times.

1. Insert the prerecorded tape.
2. Press MENU to display the VCR MAIN MENU.
3. Press 4 to display the SEARCH/COUNTER menu.
4. Press 4 to search for 0:00:00.

VCR MAIN MENU

- 1 SET CLOCK
- 2 TIMER RECORDINGS
- 3 CHANNELS
- 4 SEARCH/COUNTER

PRESS MENU TO EXIT

SEARCH/COUNTER

- 1 INDEX SEARCH FORWARD
- 2 INDEX SEARCH REVERSE
- 3 CLEAR COUNTER
- 4 ZERO SEARCH
- 5 DISPLAY: CLOCK

PRESS MENU TO EXIT

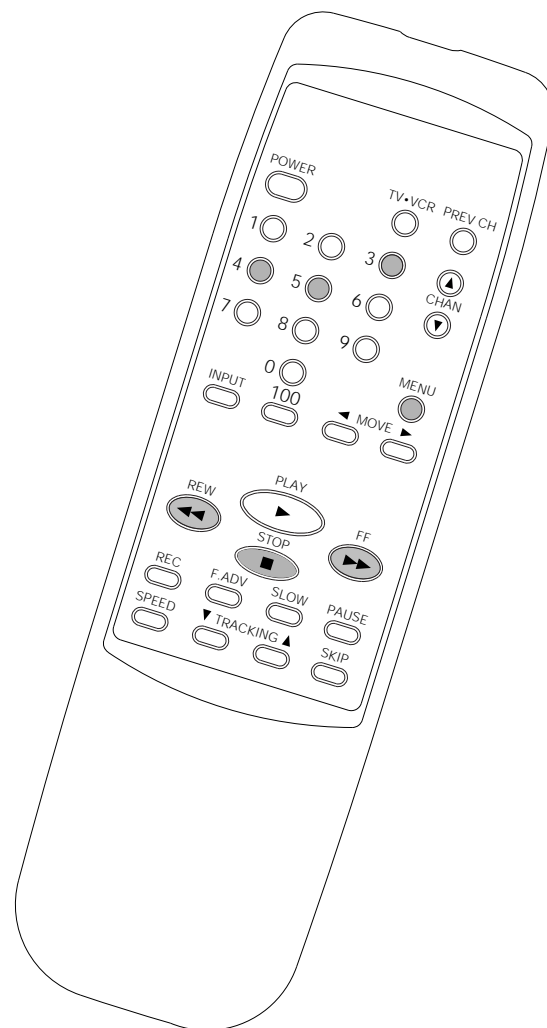

Using the Playback Features

Picture Search

You can search for a specific tape location during playback by fast forwarding or rewinding the tape. Sound is turned off during picture search. Picture search works best for tapes recorded in SP or EP speed.

Fast Forward Search

1. Press FF to search forward at a faster-than-normal speed.
2. Press PLAY to return to playback.

Rewind Search

1. Press REW to search backward at a faster-than-normal speed.
2. Press PLAY to return to playback.

Slow Motion

You can view a tape in slow motion during play or play pause. Sound is turned off during slow-motion playback. Slow motion works best in the SP or EP speed. **Slow Motion is not available in model VG2053.**

1. Press SLOW to begin slow-motion playback.
2. Use TRACKING up or down to remove any streaks from the picture.
3. Press PLAY to return to playback.

The VCR automatically switches from slow-motion playback to stop after a few minutes.

Index Search

This VCR lets you automatically record an index mark on the tape every time you stop and start recording. During playback, you can locate the program you want to play by searching for the index marks.

1. Insert the prerecorded tape.
2. Press MENU to display the VCR MAIN MENU.
3. Press 4 to display the SEARCH/COUNTER menu.
4. Press 1 to search forward or 2 to search in reverse on the tape.

Some index marks may be missed:

- A mark that is too close to the current tape location.
 - The mark at the beginning of a taped segment that is five minutes or less.
 - The first mark on the tape.
5. Press STOP to stop the index search when you see the program you want.

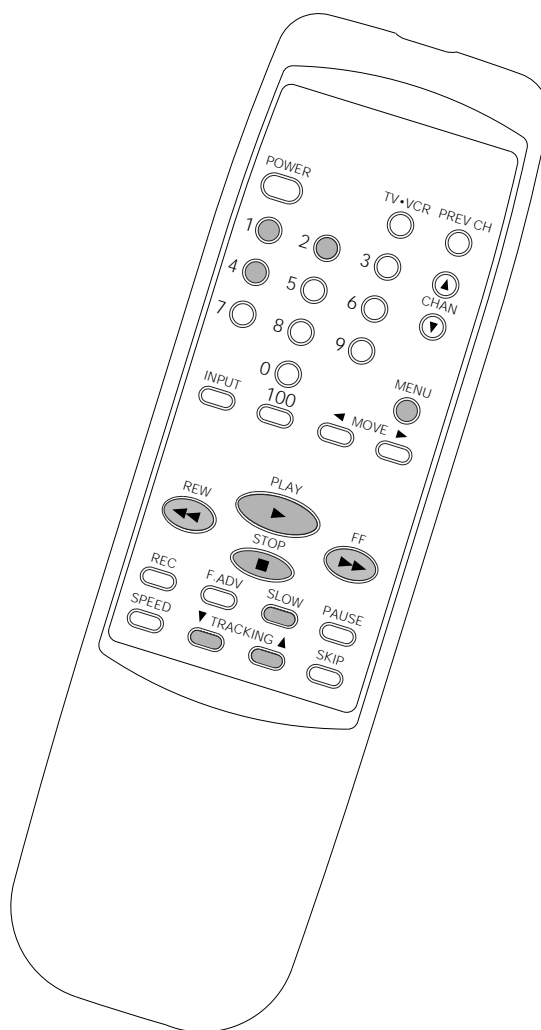
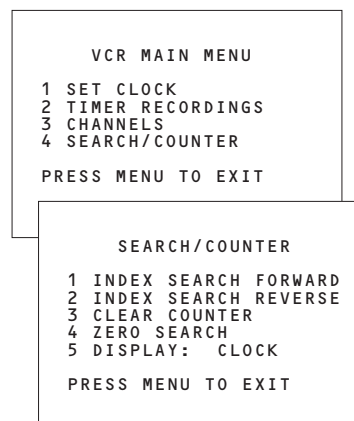

Using the Playback Features

Commercial Scan (SKIP Button)

This is useful for scanning commercials or short program segments.

1. Press SKIP during playback to advance the tape approximately 60 seconds.

Pause for Stop Action

This feature stops a tape in action and lets you examine the details of the scene on the screen. Stop actions works best for tapes recorded in SP or EP speed.

1. Press PAUSE on the remote during playback to stop the action.
2. Press TRACKING up or down to reduce any jittering of the picture.
3. Press PAUSE or PLAY to return to playback.

The VCR automatically switches from stop-action playback to stop after a few minutes.

Frame Advance (F. ADV Button)

Frame advance lets you view one stop-action frame after another. Frame advance works best for tapes recorded in SP or EP speed.

Frame advance is not available in model VG2053.

1. Press PAUSE on the remote during playback to stop the action.
2. Press F. ADV each time you want to view a frame of the scene.
3. Press PAUSE or PLAY to resume normal playback.

Automatic Tracking

The VCR has automatic tracking which adjusts the picture when you view a tape recorded on another VCR. Automatic tracking is turned on when a tape is inserted or the VCR's power is turned on.

Manual Tracking

Occasionally, you may need to manually adjust tracking on a tape recorded on a different VCR or camcorder. Tracking is used when playing a tape. It has no effect during recording.

When streaks or snow appear, press TRACKING up or down on the remote or VCR for the best possible picture.

During stop action pause, press TRACKING up or down to reduce any jittering of the picture.

For model VG4053, press TRACKING up or down to reduce streaks during slow motion play.

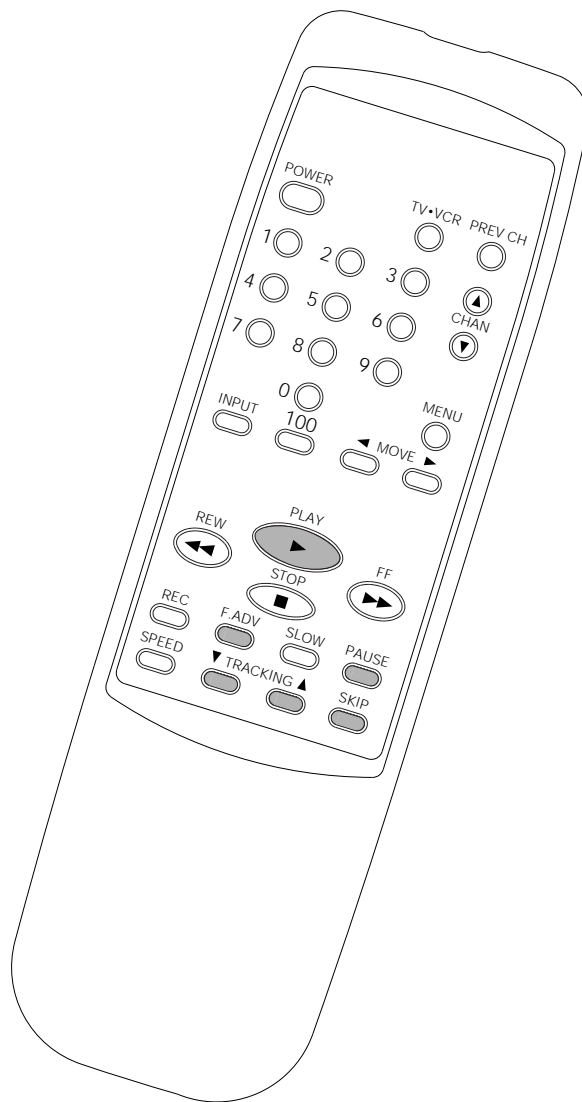

Types of Recordings

Your VCR provides different recording features. The following sections describe these features.

Recording Speeds

Press **SPEED** on the remote to select a recording speed (SP, LP, or EP). The speed you select appears on the TV screen.

SP (Standard Play) gives the best quality recording. This is why most prerecorded, rental tapes are recorded in SP. Fewer programs can be recorded on the tape. Special effects such as pause, frame advance, slow motion, and picture search work well in this speed.

LP (Long Play) gives twice the recording time of tapes recorded in SP. Special effects in playback are not recommended in LP.

EP (Extended Play) gives three times the recording time of tapes recorded in SP. Special effects such as pause, frame advance, slow motion, and picture search work well in this speed.

Cassette	Recording Time		
	SP	LP	EP
T-120	2Hr	4Hr	6Hr
T-160	2Hr 40Min	5Hr 20Min	8Hr

Recording Pause

This feature allows you to prevent recording short passages of unwanted material.

Press **PAUSE** on the remote during recording to stop and start recording.

The VCR automatically switches from pause to stop after a few minutes.

Basic Recording – Operating Instructions

To Make a Recording

Turn on the TV and tune it to the VCR viewing channel, either 3, 4, or the TV's video input channel.

1. Insert a tape with its safety tab in place. The tape indicator appears in the VCR's display panel.
2. If you are using one of the basic hookups, make sure the VCR indicator appears in the VCR's display panel. If not, press **TV•VCR** to turn it on.
3. Use **SPEED** on the remote to select a recording speed. The tape speed indicator appears on the TV screen.
4. Select the channel to be recorded. The channel number appears in the VCR's display panel and on the TV screen.
5. Press **REC** on the remote or **RECORD** on the VCR to begin recording.

To Stop a Recording

Press **STOP** on the remote or the VCR's front panel.

Watch a TV Channel While VCR is Recording a Different Channel

1. Follow steps 1 through 5 above.
2. If you are using one of the basic hookups, press **TV•VCR** to switch to the TV channel. The VCR indicator turns off in the display panel.
3. Select the channel you want to watch with the TV's channel buttons.
4. Press **STOP** on the VCR or remote when the recording is finished.

One Touch Recording

One touch recording lets you record up to four hours without using the timer program feature. The VCR turns off automatically at the end of the recording.

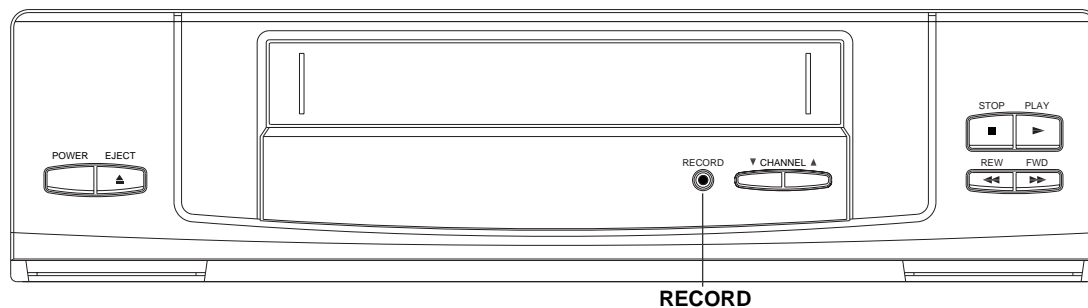

Operating Instructions

1. Turn on the VCR.
2. Insert a tape with its safety tab in place.
3. Select the channel you want to record.
4. Use SPEED on the remote to select a recording speed.
5. Press REC on the remote or RECORD on the VCR to activate recording.
6. Press REC repeatedly until the amount of recording time for the program appears on the display panel.
Each press of REC or RECORD increases the time — 30 minutes up to 4 hours. **The time remaining continuously appears in the VCR's display panel.**
The REC indicator appears in the VCR's display panel.
Press REC again to increase the recording time.
7. Press POWER to stop the recording.

Stopping a One Touch Recording in Progress

Press POWER on the remote of the VCR's front panel.

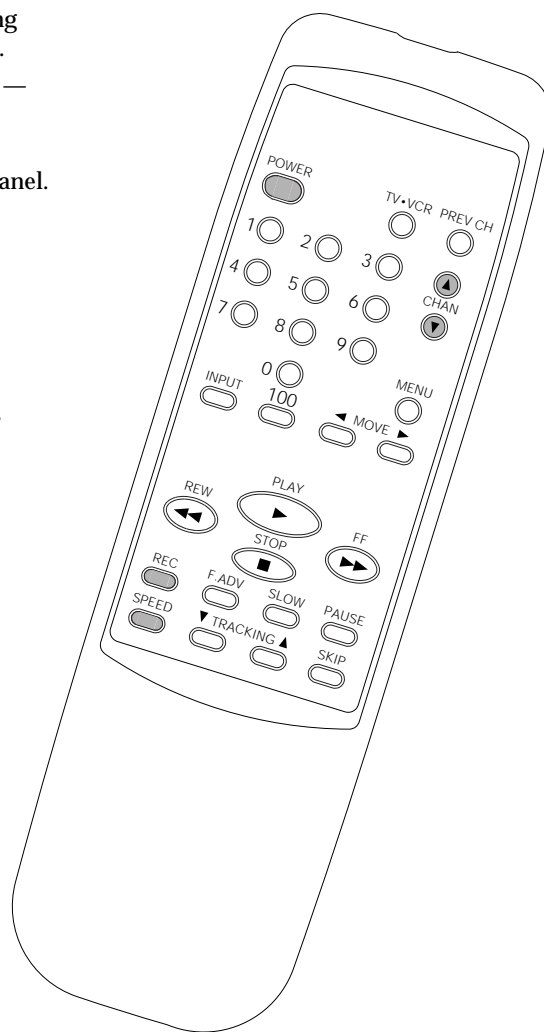

Recording While You're Away (Timer Recording)

The timer program feature lets you program the VCR to record up to eight different programs within a one year period. Before setting the timer, make sure that:

- The clock is set correctly.
- A tape with safety tab has been inserted with enough tape to record the programs.

Setting a Timer Recording

1. Press MENU on the remote to display the VCR MAIN MENU.
2. Press 2 to display the TIMER RECORDINGS menu.
3. Press the number that corresponds to the program you want to enter
4. Press the number buttons on the remote to enter the channel number, start time including AM or PM, and end time for the recording.
5. Enter the date of the recording by
 - pressing the number buttons on the remote to enter a specific month and day for a one time program
 - pressing '88' to select weekly program mode which records a program once a week, then entering the 1 to 7 code that corresponds to a specific day of the week
 - pressing '99' to select daily program mode which records a program at the same time every day.

6. Press SPEED on the remote to select a recording speed.

Press MOVE left or right on remote to correct an entry.

Press 0 on the remote to delete an entry.

7. Press MENU to save your program. If OVERLAP appears on the screen, you have entered two programs whose times overlap.
8. Repeat steps 3 – 5 for additional programs or press MENU to remove the menu from the TV screen. A reminder appears on the screen.
9. If you are using a cable box, leave it turned on and tuned to the channel you want to record. Otherwise, **turn off the VCR** before the recording begins.

The timer indicator appears in the VCR display panel.

Stopping a Timer Recording

Press POWER on the remote of the VCR's front panel.

VCR MAIN MENU

1 SET CLOCK
2 TIMER RECORDINGS

CH	TIMER START	RECORDINGS END	DATE
1	--:--	--:--	--/--
2	--:--	--:--	--/--
3	--:--	--:--	--/--
4	--:--	--:--	--/--

PROGRAM 1 (ONE TIME)

CHANNEL --
START TIME --:-- AM
END TIME --:-- AM
START DATE --/--
TAPE SPEED SP

PRESS ◀▶ TO MOVE
PRESS MENU TO EXIT

PROGRAM 1 (ONE TIME)

CHANNEL 02
START TIME 9:29 PM
END TIME 11:01PM
START DATE 3/3
TAPE SPEED EP

PRESS 0 TO DELETE
PRESS ◀▶ TO MOVE
PRESS MENU TO SAVE

PROGRAM OVERLAP
2 AND 1

REVIEW PROGRAMS TO
DECIDE WHICH ONE TO
REMOVE

PRESS MENU TO EXIT

IMPORTANT REMINDER

INSERT TAPE AND
TURN VCR OFF FOR
TIMER RECORDING

Recording While You're Away (Timer Recording)

Timer Recording From the VCR's Line Input

The line input refers to the signal coming from the VCR's AUDIO and VIDEO IN jacks. Recording from the line input is convenient if you have a satellite receiver or similar component attached to these jacks.

To timer record from the component connected to the VCR's line input, press INPUT on the remote to enter AV instead of the channel number on the TV screen during timer programming.

```
PROGRAM 1 - ONE TIME
CHANNEL      \AV
START TIME   /-:--
END TIME     -:--
START DATE   --/--/--
TAPE SPEED   SP

PRESS ◀▶ TO MOVE
PRESS MENU TO EXIT
```

Checking or Clearing Timer Recordings

1. Press MENU on the remote to display the VCR MAIN MENU.
2. Press 2 to display the TIMER RECORDINGS menu.
3. Press the number of the program you want to remove.
4. Press 0 on the remote when the program you want to delete appears on the screen.
5. Press MENU to remove the menu from the screen when you finish.

```
VCR MAIN MENU
1 SET CLOCK
2 TIMER RECORDINGS

TIMER RECORDINGS
CH  START  END  DATE
1 02  9:29  11:01  3/ 3
2  --  -:--  -:--  --/--
3  --  -:--  -:--  --/--
4  --  -:--  -:--  --/--

PROGRAM 1 (ONE TIME)
CHANNEL      02
START TIME   9:29 PM
END TIME     11:01PM
START DATE   3/3
TAPE SPEED   EP

PRESS 0 TO DELETE
PRESS ◀▶ TO MOVE
PRESS MENU TO SAVE
```

Using Two VCRs for Copying and Editing Tapes

Operating Instructions (Refer to hookup on page 6.)

Use one VCR as the playback VCR and the other as the recording VCR.

Caution: The unauthorized recording of television programs and other materials may infringe the rights of others.

1. Turn on the TV and VCRs.
2. Tune the TV to the VCR viewing channel, either 3, 4, or the TV's video input.
3. If you connected your VCR using Option A (page 6), tune the recording VCR to channel 3 or 4 – the one you selected on the back of the playback VCR.
If you connected your VCR using Option B (page 6), press INPUT on the recording VCR's remote to select the line input.
4. Insert the tape you want to copy into the playback VCR. Insert a blank tape with its safety tab in place into the recording VCR.
5. Press PLAY, then PAUSE on the playback VCR's remote when you reach the point on the tape or program where you want to begin copying. If the tape was not recorded on the playback VCR, streaks may appear and you may need to adjust tracking.
6. Press REC on the remote or RECORD on the VCR. Then, press PAUSE on the recording VCR's remote to place the recording VCR in record pause.
7. Press PAUSE on both VCRs at the same time to begin copying the tape.*
8. Edit out segments that you do not want to copy by pressing PAUSE on the recording VCR's remote to stop copying the tape. Then, locate the next segment you want to copy on the playback VCR by using FWD, REW and PLAY. Press PAUSE on the playback VCR's remote. Press PAUSE on both VCRs at the same time to resume copying.
9. Press STOP on both VCRs when you are finished.

* You may turn off the TV after the recording has started as it does not have to be on to copy a tape.

Specifications

Format:	VHS
Record/Playback	Video: Model VG2053 2-Head Model VG4053 4-Head
System:	Audio: Mono record/playback system
Video Signal System:	EIA standard: NTSC color
Antenna:	75-ohm external VHF/UHF combined antenna terminal
Tuner:	USA: 181 channels capability* (125 cable channels) Canada: 178 channels capability* (122 cable channels)
Type:	Auto Programming frequency synthesis
Power Requirement:	120V AC, 60 Hz
Power Consumption:	17 watts
Dimensions:	3.5 inches high (89 mm) 14.2 inches wide (360 mm) 12.3 inches deep (312 mm)
Weight:	9 pounds (4.1 kg)
Storage Temperature Range:	- 22°F to +149°F
Operating Temperature Range:	+41°F to +104°F

*Check your cable company's compatibility requirements.

Cleaning the VCR

Use a soft cloth or dusting attachment of your vacuum cleaner to dust your VCR. Remove dust from the ventilation holes on the top, back, sides, and bottom of the cabinet.

Plastic surfaces are easily scratched and can be marred by alcohol and various solvents. Avoid excessive use of oil-based furniture polishes since the materials used in the cabinet will accumulate more dust. We recommend using a non-abrasive, anti-static cleaner and polisher.

Location of Controls

Front Panel

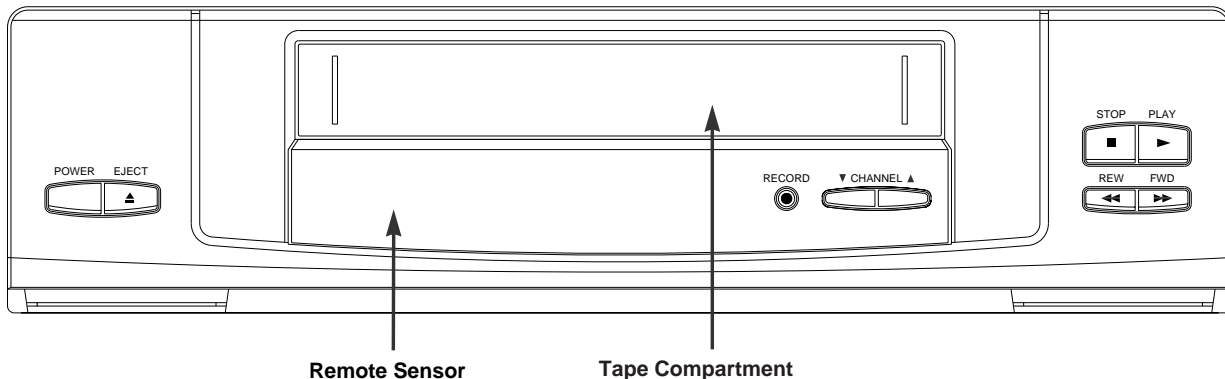

CHANNEL Up or Down

Selects next higher or lower channel in the VCR's channel memory.

EJECT

Press when the VCR is stopped to eject the cassette.

FWD (Fast Forward)

Fast forwards the tape when the VCR is stopped.

Searches the picture in forward motion during playback.

PLAY

Plays a tape.

POWER

Turns the VCR on or off.

RECORD

Start the VCR recording

Remote Sensor

Receives signals from the remote control. Aim the remote at this sensor with no objects between them.

REW (Rewind)

Rewinds the tape when the VCR is stopped.

Searches the picture in reverse motion during playback.

STOP

Stops the VCR's normal functions such as record, playback, fast forward or rewind.

Location of Controls

Back Panel

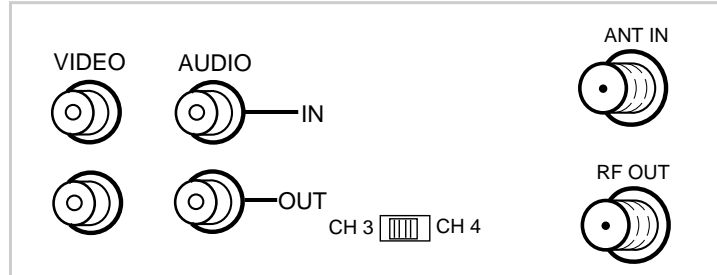

CH3 CH4 Switch

Selects the channel to which you tune the TV to see the VCR picture if you connect the VCR using one of the basic hookups.

ANT (Antenna) IN Connector

Receives a signal from an antenna or cable system when attached.

RF OUT Connector

Passes signal to TV using the cable supplied.

VIDEO IN and AUDIO IN Jacks

Receives signals from another component like a VCR or camcorder when it is connected to these jacks. Use INPUT on the remote to select.

VIDEO OUT and AUDIO OUT Jacks

Sends signals from VCR to another component like a VCR or camcorder when it is connected to these jacks.

Location of Controls

Display Panel

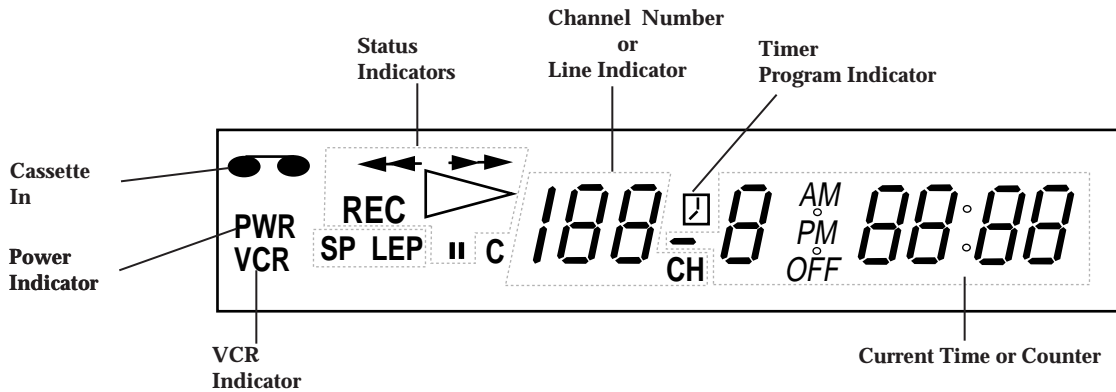

Channel number or Line Input

The channel number or line input is displayed. AU lights when you press INPUT and record from the VIDEO IN and AUDIO IN jacks on the back of the VCR.

Cassette In Indicator

Lights when a tape is in the VCR.

Power Indicator

Lights when the VCR is turned on.

Status Indicator

Shows what the VCR is doing:

- ▶ Playback
- REC and II Record-pause
- ▶ and II Frame Advance/Playback Pause
- ▶ Slow Motion
- ◀◀ Rewind
- ▶ and ◀◀ flashing Reverse Search
- ▶▶ Fast Forward
- ▶ and ▶▶ flashing Forward Search
- REC Record

Tape Speed Indicator

SP, LP, EP

Time or Counter

The current time is displayed *or* the VCR tape counter is displayed.

TIMER Indicator

Shows VCR is set for timer recording when VCR is turned off.

Flashes when the timer recording is set and there is no cassette in the VCR.

VCR Indicator

Lights when using the TV•VCR button.

When using one of the basic hookups:

- When VCR indicator is on, the picture comes from

Limited Warranty

What your warranty covers:

- Any defect in material or workmanship.

For how long after your purchase:

- Ninety days for labor charges.
- One year for parts.
- The warranty period for rental units begins with the first rental.

What we will do:

- Pay any Authorized GE VCR Servicenter the labor charges to repair your VCR.
- Pay any Authorized GE VCR Servicenter for the new or, at our option, refurbished replacement parts required to repair your VCR.

How you get service:

- Take your VCR to any Authorized GE VCR Servicenter. To identify your nearest Authorized GE VCR Servicenter, ask your dealer, look in the Yellow Pages, or call 1-800-447-1700.
- Show the service technician your evidence of purchase date.
- Pick up your VCR when repairs are completed.

What your warranty does not cover:

- Customer instruction. (Your Owner's Manual clearly describes how to install, adjust, and operate your VCR. Any additional information should be obtained from your Dealer.)
- Installation and related adjustments.
- Signal reception problems not caused by your VCR.
- Damage from misuse or neglect.
- Cleaning of video/audio heads.
- Remote control batteries.
- A VCR that has been modified or incorporated into other products or is used for institutional or other commercial purposes.
- A VCR purchased or serviced outside the USA.
- Acts of God, such as but not limited to lightning charge.

Product registration:

- Please complete and mail the *Product Registration Card* packed with your VCR. It will make it easier to contact you should it ever be necessary. The return of the card is not required for warranty coverage.

How state law relates to this warranty:

- This warranty gives you specific legal rights, and you also may have other rights that vary from state to state.

If you purchased your VCR outside the United States:

- This warranty does not apply. Contact your dealer for warranty information.

Trouble Checks

Sometimes problems can be easily solved by checking a few basic things. Check below before you call for help or take your VCR to an Authorized GE VCR Servicenter.

Trouble	Here's what to try:
No power	<ul style="list-style-type: none"> • Plug VCR into an operating outlet. • Check connections.
VCR does not respond to remote	<ul style="list-style-type: none"> • Remove batteries and hold down one or more buttons for several seconds to drain the microprocessor inside the remote and reset it. Re-install the batteries and try remote again. • Aim remote at VCR with no objects between them. • Change batteries.
Poor or no picture for normal TV viewing	<ul style="list-style-type: none"> • Press TV•VCR to turn VCR indicator off. • Switch TV to an active channel. • Check antenna connections.
Snowy or no picture during playback	<ul style="list-style-type: none"> • Press TV•VCR to turn VCR indicator on. • Check TV channel selected (3 or 4) to make sure it matches the channel selected with CH3 CH4 switch on back of VCR. • Check TV's fine tuning. • Check video cable connections between VCR and TV monitor. • Set TV monitor to video input channel. • Try another tape. • Some snow/streaks are normal during search, stop action, frame advance, and slow-motion playback.
Streaks in picture during normal playback	<ul style="list-style-type: none"> • Press the TRACKING button on the remote or VCR to move streaks up or down and out of the picture. • Check tape — it may be worn out or of poor quality.
Time counter not working or time counter does not change during zero search feature	<ul style="list-style-type: none"> • The time counter does not advance during unrecorded portions of tape. When an unrecorded segment of tape is encountered, the time counter will hold its count until recorded material is detected again. • A minus (-) appears in front of the time if you rewind the tape farther back than a counter reading of 0:00:00.
Will not record or play	<ul style="list-style-type: none"> • No cassette in VCR. • Eject and re-insert cassette. • Broken tape — try another cassette. • VCR is in pause mode. Press PAUSE on remote.
Will not record	<ul style="list-style-type: none"> • Safety tab removed from cassette. • Make sure the line indicator (AU) does not appear in the display panel for normal recording from the VCR's tuner. Press INPUT on the remote to turn the line input off.
Can't stop VCR recording	<ul style="list-style-type: none"> • Press POWER on the VCR twice.

Trouble Checks

Trouble	Here's what to try:
Rewind does not operate	<ul style="list-style-type: none"> • Tape already rewound.
Timer recording not made or wrong program recorded	<ul style="list-style-type: none"> • Cable box was not turned on at time recording was to begin. • Program entered incorrectly (wrong channel or times). • Power interruption. Reset clock. <i>See page 9.</i> • Check to see if time and date are correct — including AM/PM. • Program exceeded tape's length or tape was not rewound beforehand. • VCR was not turned off at the time recording was to start. • No tape in VCR or cassette's safety tab broken off.
Incorrect time or date	<ul style="list-style-type: none"> • Power interruption. Clock on the front panel will show -:-:-. • Clock was not set accurately (check AM/PM and date). <i>See page 9.</i> • Time counter display appears in the VCR's display panel.
VCR makes noise when stopped	<ul style="list-style-type: none"> • VCR is removing tape from heads. This is normal. The head cylinder inside the VCR continues to rotate for a few minutes after you put the VCR in the stop mode.
Will not AUTO-SEARCH active channels correctly	<ul style="list-style-type: none"> • Check antenna connections. • Check SIGNAL:CABLE/ANTENNA feature.
Cannot add or remove channels	<ul style="list-style-type: none"> • Channels must be placed in memory using AUTO CHANNEL SEARCH feature before channels can be added or removed from channel memory. <i>See page 8.</i>
Cannot select channels over 69	<ul style="list-style-type: none"> • Cable channels over 69 can only be selected if SIGNAL:CABLE/ANTENNA feature is set to CABLE. <i>Details are on page 8.</i>
Tape plays back in slow motion	<ul style="list-style-type: none"> • Press PLAY to return to normal playback.
Timer indicator flashes	<ul style="list-style-type: none"> • Timer recording programmed and no cassette in VCR.

Index

- 100 button10
- Accessories, Included7
- Add or Remove Channels from
 - Memory.....8
- ADD/REMOVE CHANNEL Menu8
- Antenna Connections2,3
- AUDIO IN Jacks.....3-6,23
- AUDIO OUT Jacks.....3-6,23
- AUTO CHANNEL SEARCH Feature8
- Back Panel23
- Batteries, Inserting in Remote.....7
- Cable System With Cable Box
 - Connections.....2,4,5
- Cable System Without Cable Box
 - Connections.....2,3
- Card, Registrationi
- CH3 CH4 Switch3-8,23
- CHANNEL Buttons8,22
- CHANNELS Menu.....8
- Checking Timer Recordings19
- Checks, Trouble.....26-27
- Choosing a Hookup.....2
- Cleaning the VCR.....21
- Clear Counter.....13
- Clearing Timer Programs.....19
- Clock on V CR Display13
- Commercial Scan.....15
- Connections2-6
 - Antenna.....2-3
 - Audio/Video Jacks.....2,3-6
 - Cable-TV2,3-5
 - Two VCRs6
- Contents1
- Copying Tape, Connections.....6
- Copying Tapes.....20
- Counter on VCR Display.....13
- Date and Time, Setting9
- Design Specifications21
- Display Panel24
- EP Speed16
- F. ADV (Frame Advance)
 - Button.....10,15
- F F (Fast Forward)
 - Button.....11,22
- First-Time Operation7-9
- Frame Advance Feature15
- Front Panel22
- Hookups
 - Antenna.....2-3
 - Amplifier/Receiver.....2,6
 - Audio/Video Jacks.....2,3-6
 - Cable-TV2,3-5
 - Two VCRs6
- Hookup, Choosing.....2
- Index Search.....14
- INPUT Button10-19
- Limited Warranty.....25
- Line Input, Recording From19
- Location of Controls
 - Remote Control10-11
 - VCR Back Panel.....23
 - VCR Display Panel.....24
 - VCR Front Panel.....22
- LP Speed16
- MENU Button10,14,18
- Number Buttons10
- One Touch Recording
 - Setting.....17
 - Stopping17
- Operating Instructions
 - Copying Tapes.....20
 - One Touch Recording.....17
 - Playing a Tape12
 - Recording a Program.....16
 - Timer Recording.....18
- Operation, First Time7-9
- PAUSE Button11
- Pause for Stop Action15
- Pause, Recording.....20
- Picture Search13
- PLAY Button11,12
- Playing a Tape12-15
- POWER Button.....7,11
- Power Indicator24
- PREV. CH (Previous Channel)
 - Button.....11
- Problems, Solving26-27
- Product Registrationi
- REC Button11,16,18,19
- REC Indicator23
- RECORD Button19,22
- Recording
 - Basic16
 - From Another VCR.....20
 - One Program While
 - Watching Another.....16
 - One Touch17
 - Pause20
 - Speeds16
 - Stopping a Basic16
 - Stopping a One Touch.....17
 - Stopping a Timer.....18
 - Timer.....18-19
 - Types Of16
- Registration Cardi
- Remote Control10-11
- Remote Sensor22
- Remove or Add Channels from
 - Memory.....8
- REMOVE/ADD CHANNEL Menu8
- REW Button11
- Safety Precautions.....i
- Searching, Picture.....13
- Sensor, Remote22
- SET CLOCK Menu.....9
- Setting a Timer Recording18
- Setting Up the VCR.....7-9
- SKIP Button11,15
- SLOW Button11,13
- Slow Motion.....13
- Solving Problems26-27
- SP Speed16
- Specifications21
- SPEED Button11,16
- Speeds, Recording16
- Startup7-9
- Stop Action Pause15
- STOP Button11
- Stopping a Basic Recording16
- Stopping a One Touch Recording.....17
- Stopping a Timer Recording.....18
- Time and Date, Setting9
- Time Counter13
- Timer Indicator24
- Timer Recording
 - Checking and Clearing.....19
 - Front VCR Line Input.....19
 - Setting18
 - Stopping18
- Tracking, Automatic and Manual.....15
- TRACKING Button11
- Trouble Checks.....26-27
- SIGNAL Feature.....8
- Turn On VCR.....7
- TV•VCR Button.....9,11
- VCR Controls.....10-11, 22
- VCR Indicator24
- VCR MAIN MENU8-9
- VCR, Cleaning21
- VCR, Turn On.....7
- VCRs Memory, Placing Channels.....8
- VCRs, Connecting for Tape Copying.....6
- VIDEO IN Jacks.....3-6, 23
- VIDEO OUT Jacks3-6,23
- Warranty, Limited.....25
- Zero Search.....13

For your nearest Authorized Servicenter
call toll-free in the U.S.A.

1-800-447-1700

Canadian Consumers –
Your toll-free numbers are:

English: 1-800-522-0338

French: 1-800-522-0445

If your VCR needs service, please
contact your dealer or the nearest Servicenter
from the yellow pages. Please do not send
any products to the Indianapolis address listed
in this manual or on the carton. This will only
add delays in service for your product.

 **THOMSON CONSUMER ELECTRONICS**

**10330 North Meridian Street
Indianapolis, IN 46290-1024**

©1995 Thomson Consumer Electronics, Inc.

Trademark(s)[®] Registered

Marca(s) Registrada(s)

Printed in Korea

Part Number 95-VG2053/VG4053-1